



Sunbelt Transformer, Ltd.
Load Interrupter Switch
Operations & Maintenance Manual

600A NEMA 3R

Sunbelt Transformer, Ltd.
1922 S. MLK Drive
Temple, TX 76504
Ph: 254-771-3777

Sunbelt Transformer, Ltd.
670 S. Dock St.
Sharon, PA 16146
Ph: 724-342-6410

600A NEMA 3R

LOAD INTERRUPTER SWITCH
FACTORY DRAWINGS

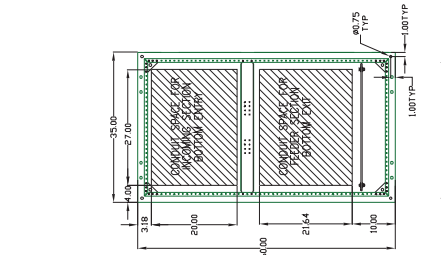

ENCLOSURE FRONT TOP VIEW

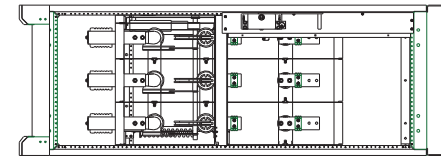

FRONT VIEW W/O COVERS

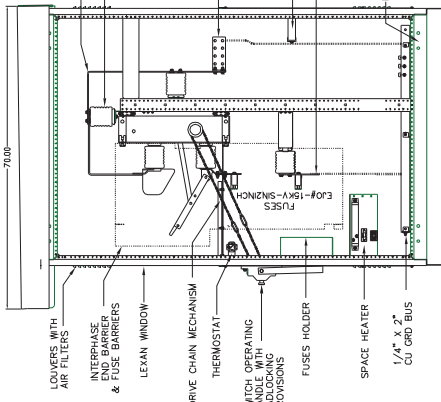

SIDE VIEW W/O COVERS

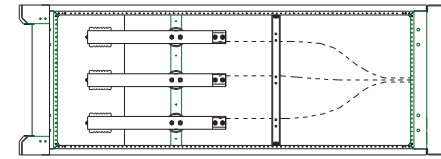

REAR VIEW W/O COVERS

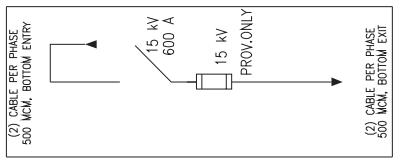

SINGLE LINE DIAGRAM

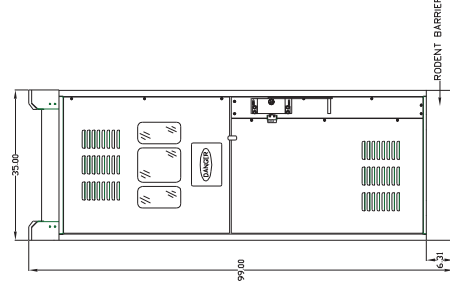

FRONT VIEW

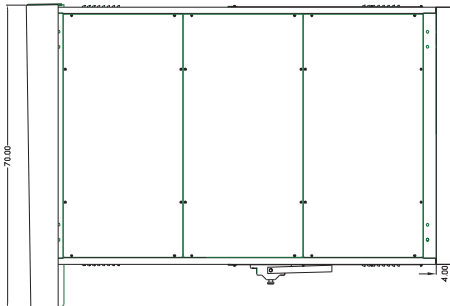

RIGHT SIDE VIEW

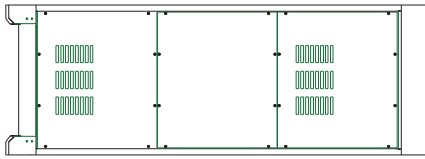

REAR VIEW

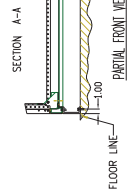
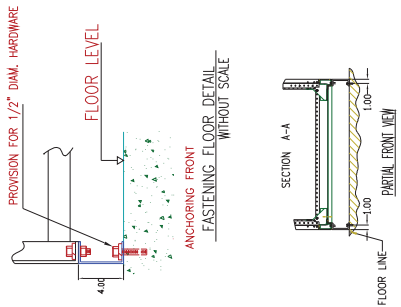

ITEM	NAMEPLATE
1	600A N3R W/FUSE
2	600A N3R W/FUSE
3	600A N3R W/FUSE
4	600A N3R W/FUSE

SIZE ADJCS	600 A	SERVICE	RENTAL	SEE PART CULL
VOLTAGE	15 KV	FREQ	60 Hz	UL LABEL
BILL LEVEL	95 KW	ITEM ISI	1.2.3 & 4	BUS MATL. CU SILVER PLATED
NORM AMPS	40 LA ASYM.	ACCESS	FRONT & REAR REQUIRED	
FAULT AMPS	40 LA ASYM.	JOB NAME	SUNBELT OPTIMAL LS23546	

ADDITIONAL ACCESSORIES:
 PORCELAIN INSULATORS
 SPARE FUSES HOLDER

DESIGNED BY		APPROVED BY		LANGUAGE		SHIP ORDERING	
				ENGLISH		LS23546	
				AREA	US ENG		
				DATE	10/21/10		
				PLANT	GEDESA RTY		SIZE
							B
				ENIS SIG			REV.
							0
							LOF 4

0 RECORD DRAWING

NO. REVISION

By: [Signature]

DATE: [Date]

By: [Signature]

DATE: [Date]

By: [Signature]

DATE: [Date]

By: [Signature]

DATE: [Date]

By: [Signature]

DATE: [Date]

By: [Signature]

DATE: [Date]

By: [Signature]

DATE: [Date]

By: [Signature]

DATE: [Date]

By: [Signature]

DATE: [Date]

By: [Signature]

DATE: [Date]

By: [Signature]

DATE: [Date]

By: [Signature]

DATE: [Date]

By: [Signature]

DATE: [Date]

By: [Signature]

DATE: [Date]

By: [Signature]

DATE: [Date]

By: [Signature]

DATE: [Date]

By: [Signature]

DATE: [Date]

By: [Signature]

DATE: [Date]

By: [Signature]

DATE: [Date]

By: [Signature]

DATE: [Date]

By: [Signature]

DATE: [Date]

By: [Signature]

DATE: [Date]

By: [Signature]

DATE: [Date]

By: [Signature]

DATE: [Date]

By: [Signature]

DATE: [Date]

By: [Signature]

DATE: [Date]

By: [Signature]

DATE: [Date]

By: [Signature]

DATE: [Date]

By: [Signature]

DATE: [Date]

By: [Signature]

DATE: [Date]

By: [Signature]

DATE: [Date]

By: [Signature]

DATE: [Date]

By: [Signature]

DATE: [Date]

By: [Signature]

DATE: [Date]

By: [Signature]

DATE: [Date]

By: [Signature]

DATE: [Date]

By: [Signature]

DATE: [Date]

By: [Signature]

DATE: [Date]

By: [Signature]

DATE: [Date]

By: [Signature]

DATE: [Date]

By: [Signature]

DATE: [Date]

By: [Signature]

DATE: [Date]

By: [Signature]

DATE: [Date]

By: [Signature]

DATE: [Date]

By: [Signature]

DATE: [Date]

By: [Signature]

DATE: [Date]

By: [Signature]

DATE: [Date]

By: [Signature]

DATE: [Date]

By: [Signature]

DATE: [Date]

By: [Signature]

DATE: [Date]

By: [Signature]

DATE: [Date]

By: [Signature]

DATE: [Date]

By: [Signature]

DATE: [Date]

By: [Signature]

DATE: [Date]

By: [Signature]

DATE: [Date]

By: [Signature]

DATE: [Date]

By: [Signature]

DATE: [Date]

By: [Signature]

DATE: [Date]

By: [Signature]

DATE: [Date]

By: [Signature]

DATE: [Date]

By: [Signature]

DATE: [Date]

By: [Signature]

DATE: [Date]

By: [Signature]

DATE: [Date]

By: [Signature]

DATE: [Date]

By: [Signature]

DATE: [Date]

By: [Signature]

DATE: [Date]

By: [Signature]

DATE: [Date]

By: [Signature]

DATE: [Date]

By: [Signature]

DATE: [Date]

By: [Signature]

DATE: [Date]

By: [Signature]

DATE: [Date]

By: [Signature]

DATE: [Date]

By: [Signature]

DATE: [Date]

By: [Signature]

DATE: [Date]

By: [Signature]

DATE: [Date]

By: [Signature]

DATE: [Date]

By: [Signature]

DATE: [Date]

By: [Signature]

DATE: [Date]

By: [Signature]

DATE: [Date]

By: [Signature]

DATE: [Date]

By: [Signature]

DATE: [Date]

By: [Signature]

DATE: [Date]

By: [Signature]

DATE: [Date]

By: [Signature]

DATE: [Date]

By: [Signature]

DATE: [Date]

By: [Signature]

DATE: [Date]

By: [Signature]

DATE: [Date]

By: [Signature]

DATE: [Date]

By: [Signature]

DATE: [Date]

By: [Signature]

DATE: [Date]

By: [Signature]

DATE: [Date]

By: [Signature]

DATE: [Date]

By: [Signature]

DATE: [Date]

By: [Signature]

DATE: [Date]

By: [Signature]

DATE: [Date]

By: [Signature]

DATE: [Date]

By: [Signature]

DATE: [Date]

By: [Signature]

DATE: [Date]

By: [Signature]

DATE: [Date]

By: [Signature]

DATE: [Date]

By: [Signature]

DATE: [Date]

By: [Signature]

DATE: [Date]

By: [Signature]

DATE: [Date]

By: [Signature]

DATE: [Date]

By: [Signature]

DATE: [Date]

By: [Signature]

DATE: [Date]

By: [Signature]

DATE: [Date]

By: [Signature]

DATE: [Date]

By: [Signature]

DATE: [Date]

By: [Signature]

DATE: [Date]

By: [Signature]

DATE: [Date]

By: [Signature]

DATE: [Date]

By: [Signature]

DATE: [Date]

By: [Signature]

DATE: [Date]

By: [Signature]

DATE: [Date]

</

BREAKMASTER LOAD INTERRUPTER SWITCH

REQ. NO. 323NA6CV-L1
 FACTORY ORDER NO. 178LS23548
 SWITCH SERIAL NO. SEE UNIT
 MANUFACTURE DATE SEE UNIT

RATED MAXIMUM VOLTAGE 15 KV
 IMPULSE WITHSTAND (BIL) 95 KV
 NORM. FREQ. WITHSTAND 36 KV
 FREQUENCY 60 HZ
 CONTINUOUS CURRENT 600 A SYM
 LOAD INTERRUPTING CURRENT 600 A SYM
 MOMENTARY CURRENT 40 KA ASYM
 SHORT TIME - CURRENT 25 KA SYM
 -TIME 2 SEC
 FAULT CLOSING CURRENT 40 KA ASYM

FUSE RATING N/A
 FUSE CATALOG NO. N/A
 INTEGRATED SWITCH AND 40 KA ASYM
 FUSE SHORT CIRCUIT CURRENT

MAIN BUS AMPACITY N/A A
 MAIN BUS BRACING N/A KA ASYM
 ENCLOSURE TYPE OUTDOOR CATEGORY B

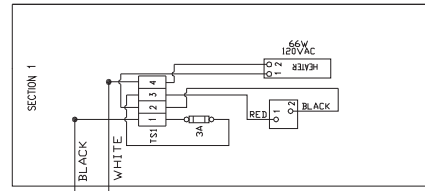

SPACE HEATER DIAGRAM

NOTE:
 1. ALL WIRING TO BE #14 AWG 90C EXCEPT WIRES THAT CONNECT TO THE HEATER. USE #14 AWG 600V, 250C TEFLOX WIRE FOR CONNECTION TO HEATER TERMINALS.

ITEM	NAMEPLATE
1	600A N3R W/FUSE
2	600A N3R W/FUSE
3	600A N3R W/FUSE
4	600A N3R W/FUSE

ADDITIONAL ACCESSORIES:
 PORCELAIN INSULATORS
 SPARE FUSES HOLDER

BUSE AIDS	600 A	SERVICE	98% SEE PROJECT
VOLTAGE	15 KV	FREQ	60 HZ
BIL LEVEL	95 KV	ITEM ISI	1.2.3 & 4
NOM AMP	40 KA ASYM	ACCESS	FRONT & REAR REQUIRED
FAULT AMPS	40 KA ASYM	JOB NAME	SUNBELT OPTIMAL LSW CVD

GENERAL ARRANGEMENT			
DESIGNED	APPROVED	LANGUAGE	SHOP ORDERING
BY	DATE	AREA	LS23548
NO.	REVISION	ESC	PLANT - GEDESALTY
0	RECORD DRAWING	ESC	PLANT - GEDESALTY
By	DATE	ESC	PLANT - GEDESALTY
By	DATE	ESC	PLANT - GEDESALTY

IMPORTANT
 DRAWINGS ARE INTENDED TO BE IN ACCORDANCE WITH APPLICABLE PURCHASE ORDER SPECIFICATIONS. UNITS UNDER THIS REQUISITION WILL BE MANUFACTURED EXACTLY AS SHOWN IN THESE FILES. IF THESE DRAWINGS DO NOT MEET CUSTOMER NEEDS YOUR IMMEDIATE RESPONSE IS REQUIRED. FEATURES NOT COVERED BY THE PURCHASE ORDER SPECIFICATIONS WILL BE IN ACCORDANCE WITH GENERAL ELECTRIC STANDARD DESIGN PRACTICES. PURCHASER'S CHANGES WILL REQUIRE EXTRA ENGINEERING, DRAFTING OR MODIFICATION OF MATERIAL AND CONSTRUCTION FOR WHICH ADDITIONAL CHARGES WILL BE MADE. THESE CHANGES MAY ALSO EXTEND SHIPMENT. TO FACILITATE ENGINEERING AND EXPEDITE MANUFACTURING, ANY CHANGES AND/OR CORRECTIONS SHOULD BE MARKED ON DRAWINGS.

323NA6CV-L1

8

600A NEMA 3R
LOAD INTERRUPTER SWITCH
INSTALLATION
&
MAINTENANCE MANUAL

BreakMaster™ Load Interrupter Switch

Installation and Maintenance



BreakMaster Load Interrupter Switch

Overview

This instruction book is expressly intended to cover the installation, operation and maintenance of GE's BreakMaster Load Interrupter Switch. This manual does not cover all possible contingencies, variations and details that may arise during installation, operation or maintenance of this equipment.

Contents

	<i>Page</i>
Section 1 - Introduction	2
1.0 Basic Description and Application	
1.1 Switchgear Identification	
1.2 Safety Features	
1.3 Safe Practices	
Section 2 - Receiving	4
2.0 Receiving	
2.1 Handling	
2.2 Storage	
2.3 Lifting Instructions	
Section 3 - Feature Identification	5
Section 4 - Installation	6
4.0 Joining BreakMaster Enclosures	
4.1 Connection of Switchgear to Transformer	
4.2 Bolting Torque Valves	
4.3 Electrical Clearances	
4.4 Grounding	
4.5 Medium Voltage Electrical Connections	
4.6 Connection to Metal Clad Switchgear Assembly	
4.7 Connection of Customer Power Cables	
4.8 Field Taping of Electrical Connections	
4.9 Securing Switchgear to Foundation	
4.10 Connection of Space Heaters to Customer's Source	
4.11 Switch Inspection Before Startup	
Section 5 - Operation	13
5.0 Mechanical Safety Interlocks	
5.1 Switch Operation	
5.2 Fuse Replacement Steps	
5.3 Shunt Trip Operating Guidelines	
5.4 Motor Operator	
Section 6 - Maintenance	21
6.0 General Requirements	
Section 7 - Selector Switch Configuration	23
Section 8 - Duplex Configuration	23
Section 9 - Auto Transfer Switchgear (LIS-ATS) Configuration	24
Section 10 - Troubleshooting	26

Section 1 – Introduction

1.0 Basic Description and Application

GE's BreakMaster Load Interrupter Switch consists of an air insulated, three pole, gang-operated, quick-make, quick-break, load interrupter switch in a floor mounted metal enclosure. It can be applied with power fuses and many other protective devices to provide safe, economical switching and circuit protection where infrequent disconnecting means is required. The BreakMaster is designed for medium voltage circuit applications ranging from 2.4kV through 15kV in 600 or 1200 load ampere interrupting ratings. The switch is operated externally from the front of the cubicle and is equipped with a quick make, quick break mechanism to open and close the switch independent of the speed with which the operating handle is moved, manually or power operated. The switchgear meets or exceeds all applicable ANSI, NEMA and IEEE standards and the Seismic requirements of the UBC zone 4 and CBC zone 4 building codes and UL listed switches are available as an option.

1.1 Switchgear Identification

A data nameplate is located beneath the switch operating handle of each BreakMaster vertical switch section (see Figure 1). Contained on this nameplate are the GE order number, serial number, drawing number, and switch style number. This information should be given to the GE sales office if a question should arise concerning the switchgear or if renewal parts are required. These numbers allow the factory to completely identify the switchgear. Also located on the nameplate are voltage and current ratings for the switch and switchgear.

1.2 Safety Features

GE's BreakMaster Load Interrupter Switch meets or exceeds all of the following standards:

Standards

ANSI/IEEE	C37.20.3
	C37.20.4
	C37.22
NEMA	SG-6
UL	UL 1008A (LIS-ATS only)
	See ANSI standards
CSA	C22.2, No. 31
	C22.2, No. 193
IEEE	693-1997

GE's BreakMaster Load Interrupter Switch has several built in features to reduce hazards and to provide proper operating sequences.

1. Door interlock prevents opening the enclosure front doors while the switch is in the closed position.
2. Switch interlock prevents manual operation of the handle mechanism with the doors open.
3. A viewing window is provided to verify each switch contact position.
4. Facilities are provided for padlocking the switch in the open or closed position.
5. Mechanical indicators show whether the switch mechanism is open or closed.
6. Key interlocks, when provided, force a sequence of operation.

⚠ WARNING

Exceeding nameplate ratings of the switchgear could cause property damage, severe injury, or death. Switchgear must be operated within its nameplate ratings.

Figure 1

BREAKMASTER LOAD INTERRUPTER SWITCH		
REQ. NO.		XXXXXXX
FACTORY ORDER NO.		XXXXXXXXX
SWITCH PART NO.		XXXXX-X
MANUFACTURE DATE		28-JUN-00
RATED MAXIMUM VOLTAGE	KV	15
IMPULSE WITHSTAND (BIL)	KV	95
NORM. FREQ. WITHSTAND	KV	36
FREQUENCY	HZ	60
CONTINUOUS CURRENT	A SYM	600
LOAD INTERRUPTING CURRENT	A SYM	600
MOMENTARY CURRENT	KA ASYM	40
SHORT TIME – CURRENT	KA SYM	25
– TIME	SEC	2
FAULT CLOSING CURRENT	KA ASYM	40
FUSE/RATING		175
FUSE CATALOG NO.		9F62FDD175
INTEGRATED SWITCH & FUSE	KA ASYM	40
SHORT CIRCUIT CURRENT		
MAIN BUS AMPACITY	A	N/A
MAIN BUS BRACING	KA ASYM	50
ENCLOSURE TYPE	CATEGORY B	INDOOR

190B9965P1 ASSEMBLED IN MEXICO

1.3 Safe Practices

Only qualified electrical workers with training and experience on high voltage circuits should be permitted to work on this equipment. They should be familiar with the work to be performed, the safety equipment required and hazards involved.

Read and understand these instructions before attempting any assembly, operation, or maintenance of this switchgear. Exceeding nameplate ratings of switchgear could cause property damage, severe injury, or death.

1. Make sure all power sources are disconnected before making any adjustments or performing maintenance.
2. After opening the switch and before opening the door, use viewing window to insure that all three switch blades are open. If necessary, use a flashlight to verify.

WARNING

There are several interlocks on the switches. They are for personnel and/or equipment protection. Under no circumstances should they be made inoperative when switch is in service. To do so could cause bodily injury or property damage.

3. Never energize the switch without the arc chutes and barriers installed.
4. Always be sure that all hardware is in place and bolted tightly before putting switch into operation.
5. Before replacing covers, carefully inspect buswork and phase barriers to insure that no tools or other objects are accidentally left inside the unit.

NOTE

Any work done on this equipment must conform to the appropriate OSHA and NFPA standards.

Section 2 – Receiving

2.0 Receiving

A visual inspection – inside and out – should be performed immediately upon receipt of the switchgear and before removing it from the truck. Shipping papers should be checked to ensure all boxes or other accompanying pieces have been received. If any damage or shortages are evident, a claim should be filed at once with the carrier and the nearest GE sales office.

The data nameplate for each switch assembly is located beneath the switch operating handle. The order number, serial number, and drawing number are located on this nameplate and should be given to the GE representative whenever identification of the assembly is required.

2.1 Handling

Removable lifting plates are provided on the top of the BreakMaster structure for insertion of hooks to lift the complete structure. This is the only recommended method of moving the BreakMaster structure. Extreme care should be used not to damage or deform the unit if other moving methods are employed.

2.2 Storage

If it is necessary to store the equipment before installation, keep it in a clean, dry location with ample air circulation and heat to prevent condensation. Like all electrical apparatus, these units contain insulation that must be protected against dirt and moisture. **OUTDOOR UNITS MAY BE STORED OUTSIDE ONLY IF ROOF CAPS ARE INSTALLED, SPACE HEATERS ENERGIZED AND ANY OPENINGS ARE COVERED.**

2.3 Lifting Instructions

1. Do not pass cables or ropes through support holes.
2. Always use load rated shackles or safety hooks in support holes.
3. Rig so that legs of sling (Figures 2 and 3) are no less than 45 degrees from horizontal.

NOTE:

Figure 2 – Using lifting slings, spreader and blocking which are not furnished with equipment.

Figure 3 – Using lifting plates, angles or beams which are furnished with equipment.

Figures 2 and 3

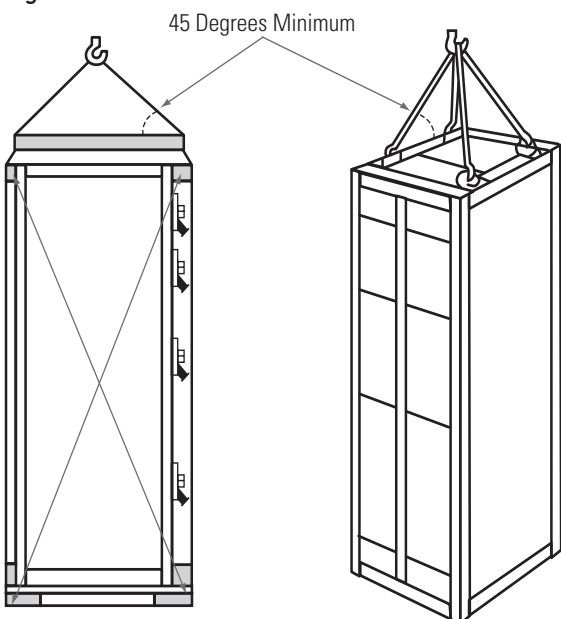

BreakMaster Load Interrupter Switch

Section 3 – Feature Identification

3.0 Front View with Top Door Open

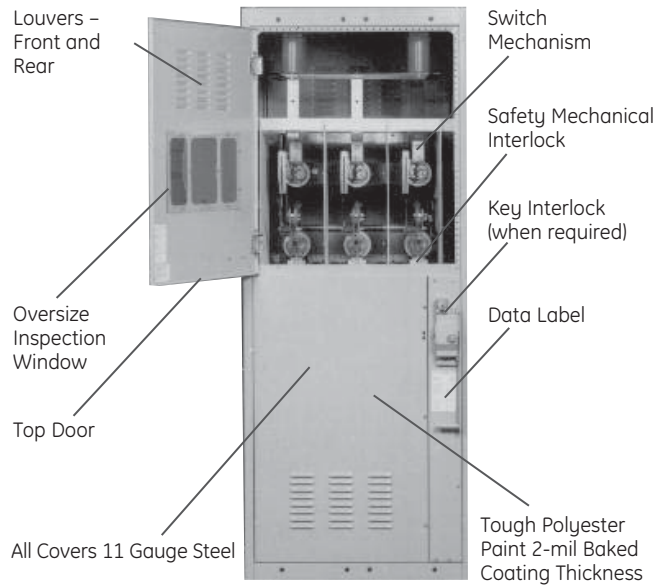

3.1 Front View with Lower Door Open

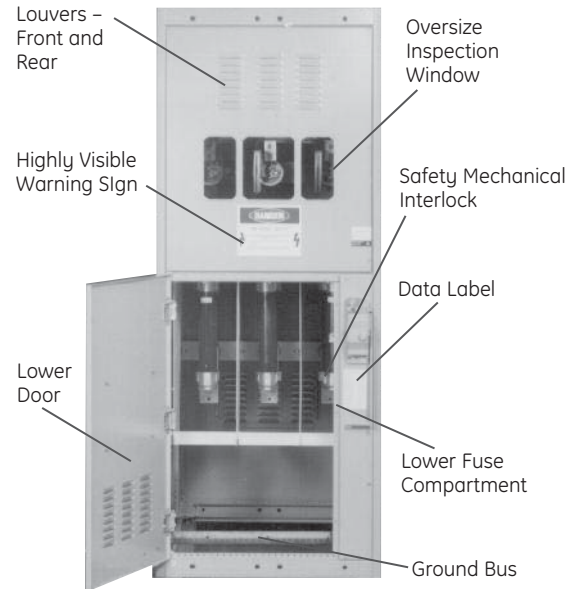

3.2 Side View with Covers Removed

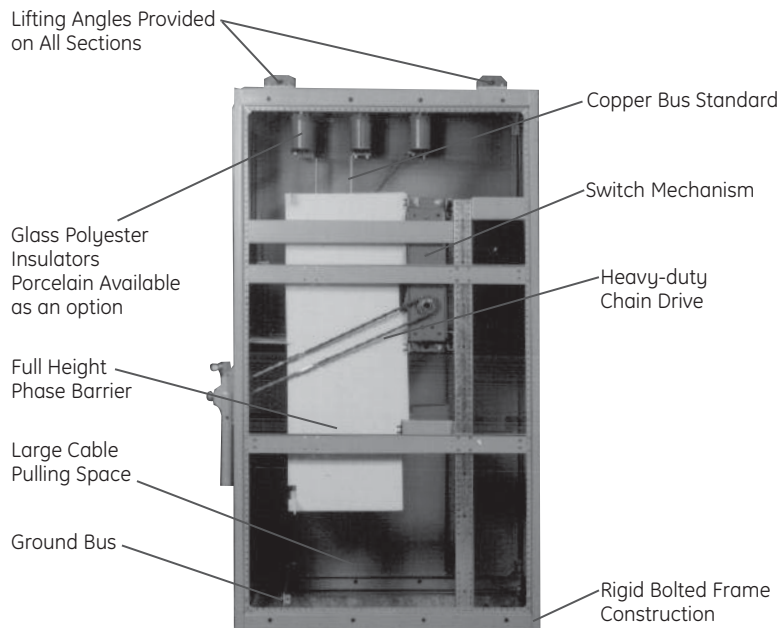

Section 4 – Installation

4.0 Joining BreakMaster Enclosures

4.0.0 Access to BreakMaster Vertical Sections Containing Switches

Each BreakMaster load interrupter switch is shipped from the factory in the closed position to maintain alignment during shipping and handling. The safety interlocking prevents opening of the door of the vertical section when the switch is closed. In order to gain access to the interior, be sure the switchgear is on a true and level surface. To open a manually operated BreakMaster switch, pull the release button and rotate the handle to the open position.

When handling the BreakMaster enclosure and moving switches, be sure the switches are in the closed position. Do not operate switches unless they are setting on true and level surfaces.

4.0.1 Identification of Shipping Splits

Refer to the front view drawing. Below this drawing, shipping splits will be identified in relation to group numbers for each cubicle. Normally shipping sections will not exceed 90 inches in width.

4.0.2 Procedures for Joining BreakMaster Enclosures at Shipping Splits

The joining of sections consists of 2 bolted connections on the top and bottom of each depth frame member. In addition, 2 bolted connections are made on each vertical frame member. The vertical connections are located $\frac{1}{3}$ and $\frac{2}{3}$ up from the bottom of the BreakMaster Load Interrupter Switch (if 90" high switch, then connections are made at 30" and 60" off the ground).

Make any main and ground bus connections using splice plates and hardware furnished. Bus bars are usually tin or silver plated. To insure a proper electrical connection, care should be taken to protect the plating from damage. DO NOT use joint compound.

WARNING

Wipe surfaces with clean, dry cloth to clean.
Cleaning bus joints with abrasive or chemical cleansers may remove plating, which may cause joint overheating.

4.1 Connection of Switchgear to Transformer

4.1.1 Indoor Assemblies

Holes are pre-drilled in the side of the BreakMaster structure to match holes provided in the transformer.

4.1.2 Outdoor Throat Connection

- Switch and transformer should be brought together to give spacing of $\frac{1}{2}$ inch between throat flanges.
- Apply double bead of caulking material supplied with Breakmaster switchgear to outside surfaces of both flanges.
- Move switch and transformer together to compress caulking material.

BreakMaster Load Interrupter Switch

4.2 Bolting Torque Values

BreakMaster Load Interrupter switches are furnished with medium carbon steel hardware having a high tensile strength of 120,000 psi. SAE 5 or better hardware should be used for any additional bolting. The use of a torque wrench is recommended to assure the following torques. These torques apply to aluminum or copper connections. When torquing bolts the following values are nominal:

- 1/4" bolts – 4 lb. ft.
- 5/16" bolts – 9 lb. ft.
- 3/8" bolts – 16 lb. ft.
- 1/2" bolts – 39 lb. ft.
- 5/8" bolts – 80 lb. ft.

Flat washers and lock washers should be used for all connections. Washers should not be included under the heads of carriage bolts.

4.3 Electrical Clearances

The following minimum clearances should be maintained after field modifications:

	<u>2.4 kV - 5kV</u>	<u>7.2 kV - 15kV</u>
Between live parts of adjacent phases:		
Through air:	3 1/2"	5 3/4"
Over Surface:	3 1/2"	5 3/4"
Between live parts and grounded metal through air over surface:	3 1/2"	5 3/4"

4.4 Grounding

The ground bus is bolted to the uprights of the frame structure. It is arranged so that connections to the station ground can be made in any unit. A ground bus is included in each section for connecting the BreakMaster equipment to the station ground.

WARNING

It is very important that the equipment be adequately grounded to insure that all parts of the equipment, other than live parts, need to be at ground potential.

4.5 Medium Voltage Electrical Connections

4.5.1 Connection by Cable Supplied with BreakMaster Switch

- a. Cables are not factory pre-cut to proper length. Installer must cut to fit.
- b. Since factory cables are unshielded, they must be properly separated from each other, from all grounded metal parts, and from transformer bushing/terminals of other phases.
- c. BreakMaster conforms to ANSI standards concerning phasing. Phases are arranged A, B, C, front to rear, top to bottom, and left to right at connection points unless otherwise noted on the drawings. The installer is responsible for maintaining continuity of phasing throughout the system.
- d. Lugs are provided with the switchgear for terminating cable to the transformer bushings/terminals.

4.5.2 Connection by Bus Bar

- a. Flexible bus straps or splice plates and hardware are furnished with the BreakMaster Load Interrupter Switch.
- b. Copper bus bar is tin or silver plated.

BreakMaster Load Interrupter Switch

4.6 Connections to Metal Clad Switchgear Assembly

4.6.1 Indoor Switchgear

Holes are predrilled in the side of the BreakMaster Load Interrupter Switch structure to match holes provided in Metal Clad switchgear. Bolt together using hardware furnished with BreakMaster Load Interrupter Switch.

4.6.2 Outdoor Switchgear

- Position units side by side. Holes in BreakMaster switch side sheet around bus cutout will match holes in metal clad switchgear flange.
- Press weather stripping putty on to flange for weather-tight seal.
- Join enclosures using bolts supplied with BreakMaster switch. Opposite side of metal clad switchgear flange has nuts welded in place for ease of connection.

4.7 Connection of Customer Power Cables

Cable termination space is provided in the cubicle for top or bottom cable entry as shown on the outline drawings. Adequate electrical clearance must be maintained between cables, energized parts, and grounded metal parts. It is also the installer's responsibility to adequately support cables such that insulators or bus bars do not carry the strain of the cables.

Tin-plated aluminum clamp type terminals are suitable for acceptance of copper or aluminum cable. If potheads or other special terminations are supplied, termination should be made according to the terminator manufacturer's instructions.

4.7.1 Installation Procedure for Main Cables when Cable Brace is Provided

Align conduit holes in a linear orientation directly over or as close as possible to the braces. Consideration should be given to installing conduits or sleeves which might be required for future connections.

Run and bend the main cable in a most convenient orientation, making sure the main cable has been located directly up against the cable braces before it connects to the main cable terminals. Lash the main cable according to Figure 4 above, using a 3/8" nominal nylon rope, or a polyester braided rope having a tensile strength of 2000 lbs. minimum, making 6 revolutions around the "A" and "B" phase main cables and 6 revolutions around the "B" and "C" phase main cables. Continue wrapping the cord around the main cable lashing and around the cable braces (if applicable), in between the phases, tying a knot to the cable brace or cable as you complete your last revolution. All revolutions should be made as tight as possible so as to prevent whipping during short circuits. The nylon rope is not provided.

Figure 4

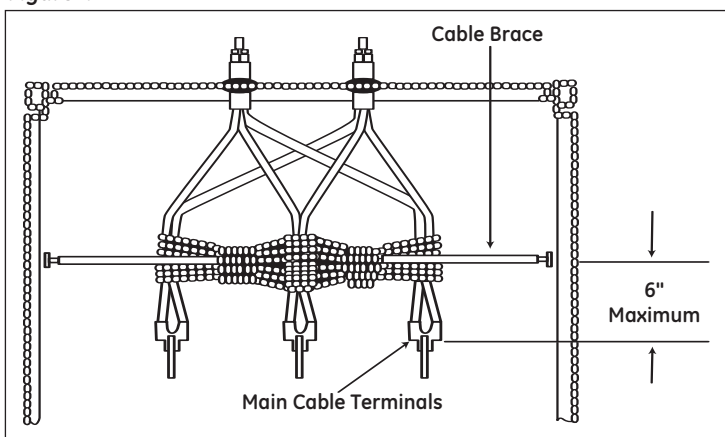

4.8 Field Taping of Electrical Connections

4.8.1 Materials

- a. Filler – insulation putty – GE Part #: 55A213957
- b. Insulating tape – black, linerless H.V. EPR tape – GE Part # MMC#130C1 (1") or MMC#130C2 (2")

4.8.2 Procedure

- a. Clean area of dirt and foreign matter per Section 6.0.2
- b. Apply filler – installation putty – over bare conductor and hardware to cover and smooth out the surface. Blend contour into preinsulation surfaces. Cover conductors and hardware with at least $\frac{1}{8}$ " of filler.
- c. Apply insulating tape, lapping and layering as specified in chart below. Tape must overlap factory installed insulation by 1". Elongate insulating tape 10 to 25 percent during application to insure a smooth, tight fit. Should a tape roll be used up, start the new roll by overlapping any previous end by $\frac{1}{2}$ turn.

Chart 1: Taping Chart

	Lap of Tape	No. of Layers
Up to 5 kV	$\frac{1}{2}$	1
Over 5 kV to 15 kV	$\frac{2}{3}$	2

4.9 Securing Switchgear to Foundations

All anchoring hardware and necessary devices are to be supplied by the installer.

Indoor and outdoor units can be secured to the foundation using $\frac{1}{2}$ " diameter anchor bolts (SAE Grade 5 or stronger). The four $\frac{3}{8}$ " holes in the base for these bolts are shown on the floor plan included with the drawings.

4.10 Connection of Space Heaters to Customer Source

Space heaters, when supplied, must be energized to prevent condensation. Heaters are supplied for 120 or 240 volt sources as shown on drawings.

For lineups or units with heater control devices, heaters will be internally wired and brought to a terminal block. A wiring diagram will be furnished with the drawings showing connection points for power.

4.11 Switch Inspection Before Setup

The following procedure should be performed to insure proper operation of the switch. Open and close the switch 2-5 times in succession. Do not attempt to grind the blades with powdered emery or other abrasives. Such practice inevitably results in poor contact and overheating.

Switch contact adjustment should be checked as follows:

1. Operate the switch several times checking for main blade and arcing blade alignment with the stationary contacts and arc chute.
2. Check switch resistance by using a low resistance ohm meter connected between the jaw spade terminal and the hinge spade terminals. Do this measurement of each pole of the assembly.

Any low resistance meter capable of measurements in the micro-ohm range may be used.

Suitable meters include:

Valhalla Scientific, Inc.
Model 4150 ATC
Digital Ohmmeter

Biddle Instruments
Cat. No. 247350
Digital Low Resistance Ohmmeter

If the switch does not move freely or the resistance is over 80 micro-ohms then the switch must be readjusted using the following switch alignment procedure and adjustment procedure (see Section 4.11.1).

 CAUTION
The hinge and jaw contacts are sliding joints and overtightening can cause the switch not to open and severely damage the mechanism.

4.11.1 Switch Alignment and Adjustment Procedure

⚠ DANGER

Make sure that all power sources are deenergized before attempting any maintenance.

Figure 5

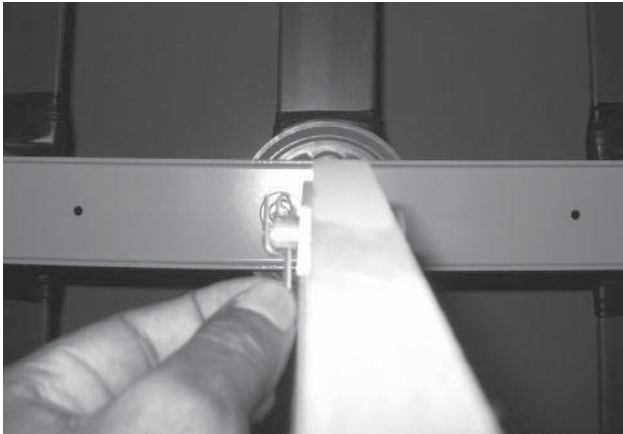

Step 1: Disconnect Pushrods

Remove cotter pins and clevis pins that connect pushrods to operating arms of each pole of switch. See Figure 5.

Figure 6

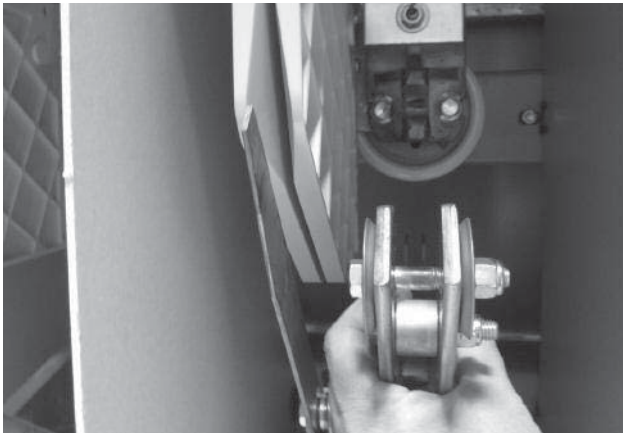

Step 2: Main Blade Alignment

Disengage switch blades by pulling outward on the main switch blade until the main blades are separated from the jaw casting. Continue to pull outward until arcing blade disengages from the arc chute. See Figure 6.

⚠ WARNING

The arcing blade is under spring pressure and snaps open when clear of the stationary arcing contacts within the arc chute.

Figure 7

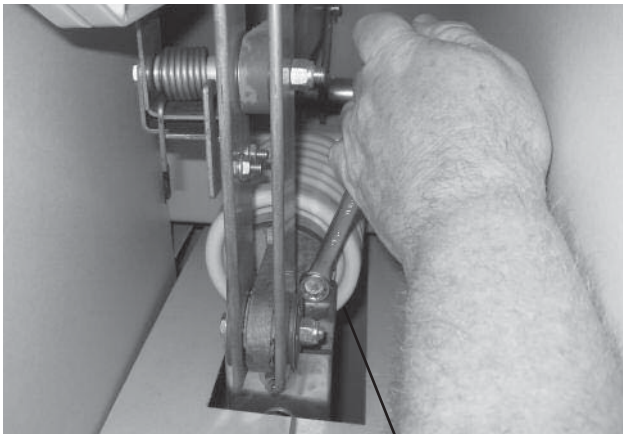

If the main blades do not align with the jaw contacts, loosen the hinge casting mounting bolts and move the pole assembly. Then re-tighten the bolts. See Figure 7.

Hinge casting

BreakMaster Load Interrupter Switch

Figure 8

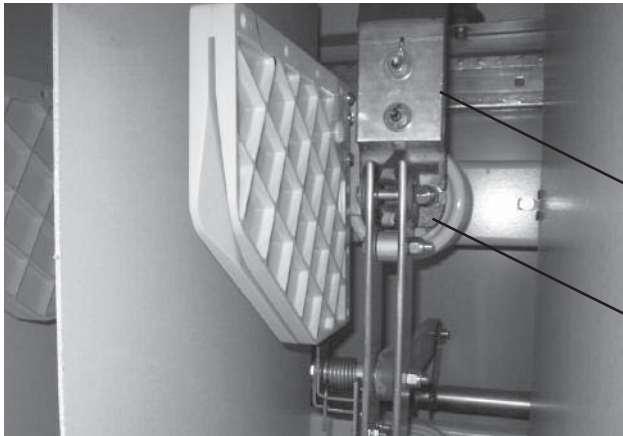

Check that the jaw casting contact surfaces align with the main blades. If necessary to adjust, loosen the jaw casting mounting bolts, tap on the spade terminal to align, then re-tighten the bolts. See Figure 8.

Spade terminal

Jaw casting

Figure 9

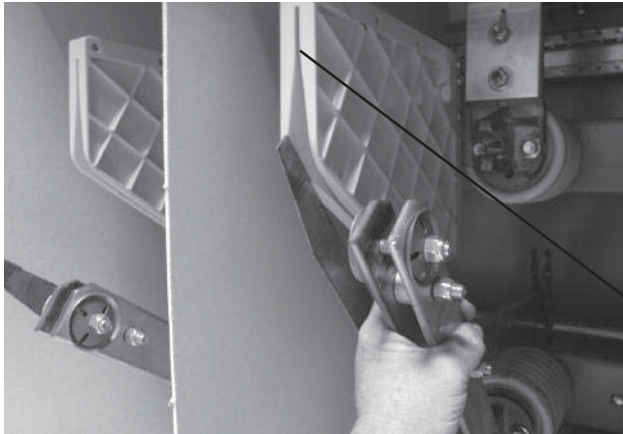

Step 3: Arcing Blade Alignment

Slowly move blade in and out to check for proper alignment of arcing blade with the opening in the arc chute. If necessary, adjust the jaw casting by loosening the mounting bolts and lightly tapping the arc chute mounting bracket. Re-tighten the bolts. See Figure 9.

Arc chute

Figure 10

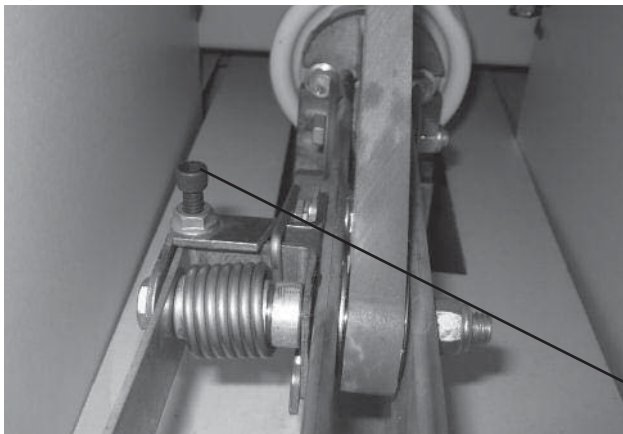

If any corrections in the arcing blade position are necessary (after all previous steps have been completed), loosen the locknut on the arcing blade adjusting screw – see Figure 10 – and turn the screw either in or out to obtain positioning of arcing blade. Re-tighten the locknut.

Adjusting screw

Figure 11

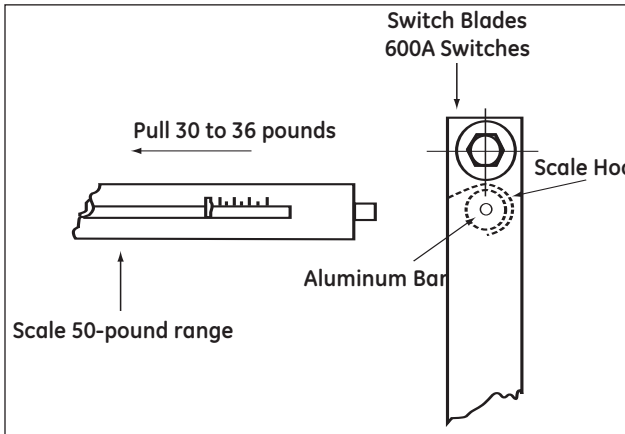

Step 4: Hinge Contact Pressure Adjustment

Open the switch until the arcing blade just clears the arc chute. Connect a spring scale to the main blades approximately 1 1/2" below the jaw contact. Some switches are equipped with a spacer just below the jaw. This provides a convenient point to connect the scale. On other switches, use a "tee" adapter allowing equal force on both blades. See Figures 11, 12, and 13.

NOTE

If the nylon insert locknut is removed for any reason, it must be replaced with an "ESNA" stopnut.

Figure 12

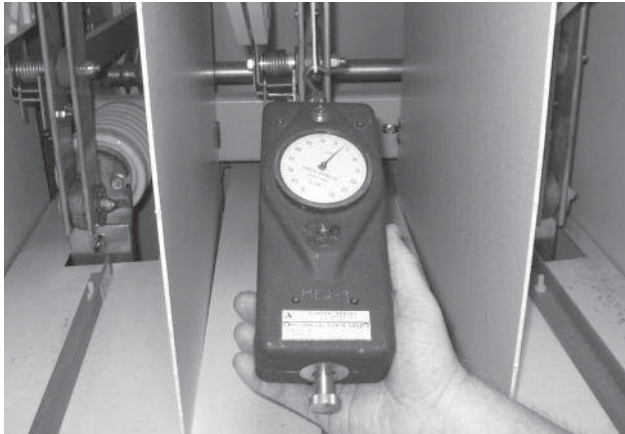

A force of 2-4 pounds should be necessary to move the blades. Loosen or tighten the hinge bolt as necessary to meet the 2-4 pound requirement.

Figure 13

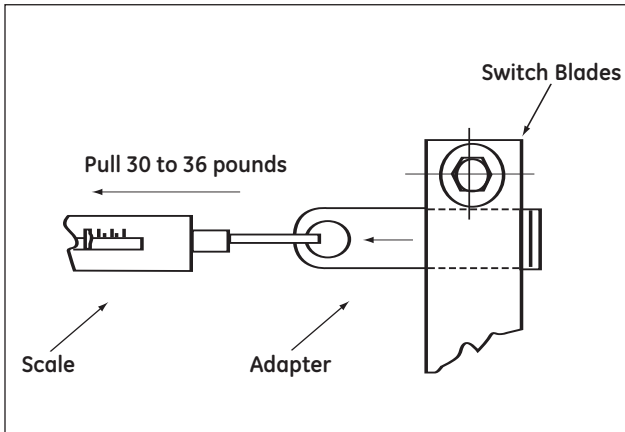

Step 5: Jaw Contact Pressure Adjustment

Close each switch pole and connect a spring scale as described in Step 4. A force of 30-36 pounds should be necessary to open the switch blades. Loosen or tighten the jaw contact bolts as necessary to meet the 30-36 pound requirement. See Figures 11, 12, and 13 for spring scale placement.

NOTE

Spring scale referenced in Steps 4 and 5 should be Chatillon model# IN-10MRP for force range 10 lbs. 4 oz. or Chatillon model# IN-50MRP for force range 50lbs. 8oz. or equivalent.

Section 5 – Operation

5.0 Mechanical Safety Interlocks

The GE BreakMaster switch is equipped with switch interlocks and door interlocks as well as provisions for padlocking in either the open or closed position.

⚠ DANGER

Make sure that all power sources are deenergized before attempting any maintenance.

⚠ WARNING

Defeating or disengaging safety interlocks on a BreakMaster switch that is connected to a power source may result in property damage, bodily injury or death.

DO NOT DEFEAT OR DISENGAGE ANY SAFETY INTERLOCKS.

5.0.1 Switch Interlock

Figure 14

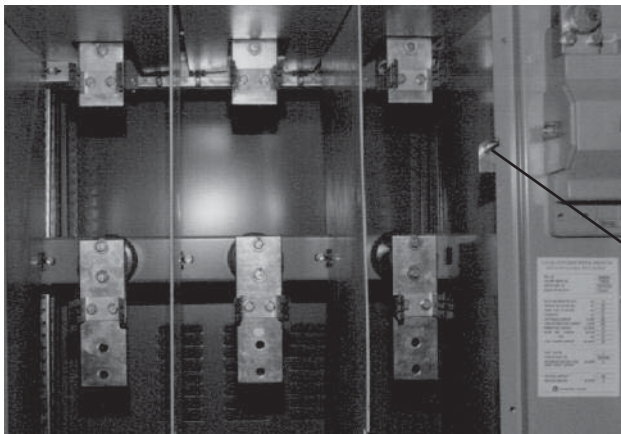

This interlock prevents inadvertent closure of switch if the enclosure door is open. When the door is closed, the push rod is depressed by the door to move the safety latch out of the blocking position. See Figure 14.

Door operated pushrod

5.0.2 Door Interlock

Figure 15

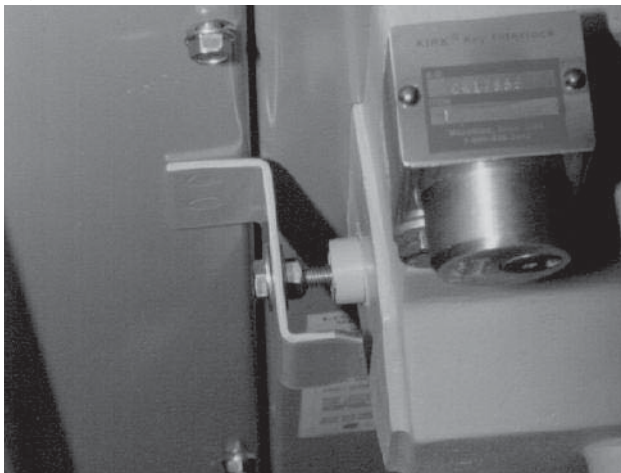

This interlock prevents the door of the enclosure from being opened when the switch is closed. When the switch is closed the door latch is, captured by the pivot of the operating handle, preventing the door from being opened. See Figure 15.

BreakMaster Load Interrupter Switch

5.0.3 Upper Door Interlock

The lower switch access door has a metal interlock which forces the upper door to be closed in order to close the lower door.

DANGER

Make sure that all power sources are deenergized before attempting any maintenance.

5.0.4 Key Interlocking

Key interlocks are supplied when specified. Certain BreakMaster switchgear configurations require key interlocks and they are therefore included. Standard schemes are available for locking the switch in the open position or the closed position as well as locking the main door closed. Numerous other schemes are available for special requirements, which can coordinate with upstream or downstream devices supplied by GE or other equipment manufacturers.

WARNING

Key interlocks, when supplied from the factory, will have a key for each lock; however, for correct sequence of operation, one or more of the keys must be eliminated. These excess keys must either be destroyed or locked away where they will not be accessible to operating personnel. Failure to do so may result in severe injury or death.

CAUTION

Operating a BreakMaster switch with a key interlock bolt extended will result in equipment damage and may also expose a person to bodily injury or death. The key must be inserted into the interlock and rotated to retract the locking bolt before operating a BreakMaster switch.

5.1 Switch Operation

To manually close or open the switch, pull the release pin and rotate the handle up or down as appropriate. This charges the compression spring, and as the spring lever goes over center, the stored energy of the spring is transferred to the shaft which snaps the switch open or closed. The blades thus move at a predetermined speed that is independent of the operator.

The quick-make mechanism provides power to overcome blowout forces that occur if the switch is closed into a fault. However, these forces are not transmitted to the operating handle since it is not rigidly connected to the blades. Therefore, the switch can be safely closed under short circuit conditions within its fault-close rating.

Load interruption is accomplished by a flicker blade and engaging contact fingers located inside an arc chute. On opening the switch, the main blades open first and all current is shunted through the spring loaded flicker blades. Further travel of the main blades causes the flicker blades to snap out of their contact fingers where associated arcing takes place within the arc chutes.

5.2 Fuse Replacement Steps

⚠ DANGER

When accessing fuses, failure to assure that the fuses are deenergized may result in equipment damage, bodily injury or death.

Make sure that all power sources are deenergized before attempting to access the fuses.

1. All upstream devices that could energize the fuse should be opened, padlocked, and tagged so that inadvertent closure cannot create a hazard.
2. The BreakMaster switch is opened by rotating the handle downward.
3. Before opening the door look through the viewing window to visually verify that all blades are disengaged from their stationary contacts. Use a flashlight if necessary.
4. After opening the door, an appropriate medium voltage-sensing device, such as a TIC tracer rated up to 15kV, should be used to determine if voltage is present. An example would be TIC brand, TIF320HV.
5. If no voltage is present, a suitable grounding device should be attached to the fuse terminals to discharge any static charge and assure that the fuse terminals remain at ground potential.
6. Remove fuse by pulling fuse forward until it is clear of the fuse clips. Install new fuse by inserting it into the fuse clips. Make sure the clips fully contact the fuse ferrules. See Figures 16 and 17.

Figure 16
Installed Fuses

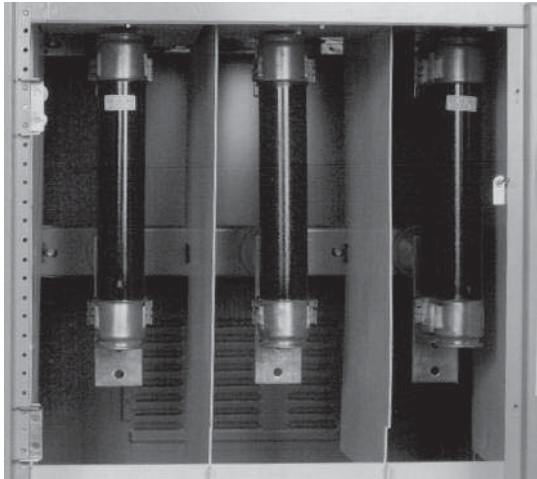
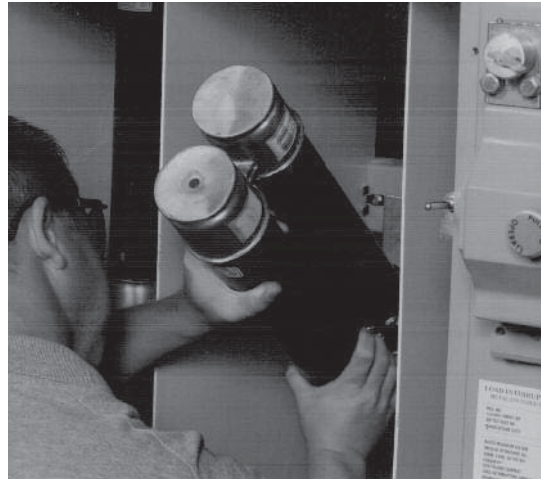

Figure 17



5.3 Shunt Trip Operating Guidelines

1. Close the switch using the operating handle
2. Rotate operating handle down until it stops (About 130 Deg. downwards). Switch is now "Armed" and is "Set to trip."
3. Remove and store the operating handle
4. Switch may be tripped "Open" by pulling the manual trip knob or electrically with the trip solenoid. Exercise caution and keep clear of the switchblades.

To gain access to interior:

- Pull manual trip knob and turn Key-1 above knob. Switch is now tripped and Key-1 is released.
- Move the switch operating handle to full down position. Insert Key-1 into lock above operating handle and turn both Key-1 and Key-2. Switch is locked open. Key-2 is released.
- Insert Key-2 into lock on door and turn to unlock door.
- Reverse sequence to close the switch.

WARNING

This switch contains a stored energy mechanism. Keep all parts of body clear of switchblades. Operation of either manual trip knob or solenoid will automatically open the switch with great force. Allow only qualified persons access to switch interior.

5.4 Motor Operator

The motor operator utilizes a powerful direct drive motor assembly to charge the latching spring mechanism, which opens and closes the interrupter switch, not the electric drive. Due to the high level of torque generated by this drive assembly, please read all instructions and carefully follow the sequence to prevent physical damage to the drive unit, interrupter switch or cubicle. If, after reading these instructions, you still have questions, please contact GE prior to beginning this procedure.

The sequence of operation as outlined in this instruction book is based on a "Typical" motor operated drive assembly. Based on particular application requirements there may be internal control modifications not shown in the "typical" operation sequence. The terminal designations for the major components, such as the microswitches, motor, reversing contactor, etc., are standard with GE and should not change. Please compare the standard drawing for the appropriate control voltage with the wiring schematic shipped with the unit. This should be done prior to beginning any work.

A key lock containing a microswitch retains the switch handle. Placing the handle in the lock and rotating the key prevents removing both handle and key. The microswitch is then closed to complete the motor control power circuit.

CAUTION

Do not attempt to bypass the microswitch by removing the handle and placing it in the operating mechanism. To do so will allow the motor to operate and rotate the handle. Serious injury could occur.

CAUTION

Do not operate until all adjustments as described in the "adjustments" section are complete.

BreakMaster Load Interrupter Switch

Operation (motor operated switch)

This drive system consists of:

1. Heavy Duty Universal Gear Motor (M)
2. Full-Wave Bridge Rectifier (RECT)
3. Double-throw Contactor 3-Pole or 4-Pole (89XY)
4. Industrial Solenoid (SOL)
5. Clutch and Spring Mechanism Coupled to the Drive Motor (CL & SP)
6. Load Interrupter Switch Auxiliary Cam Switch
Chain Driven
Normally Open (89/OP)
Normally Closed (89/CL)

See Kinematic Diagram (Figure 18). When the main interrupter (89) is signaled to operate (close), the 89X coil (Figure 19) is energized, closing all of its contacts and mechanically blocking 89Y from being energized. Solenoid (SOL) is then energized.

Figure 18
Motor Drive System Kinematic Diagram

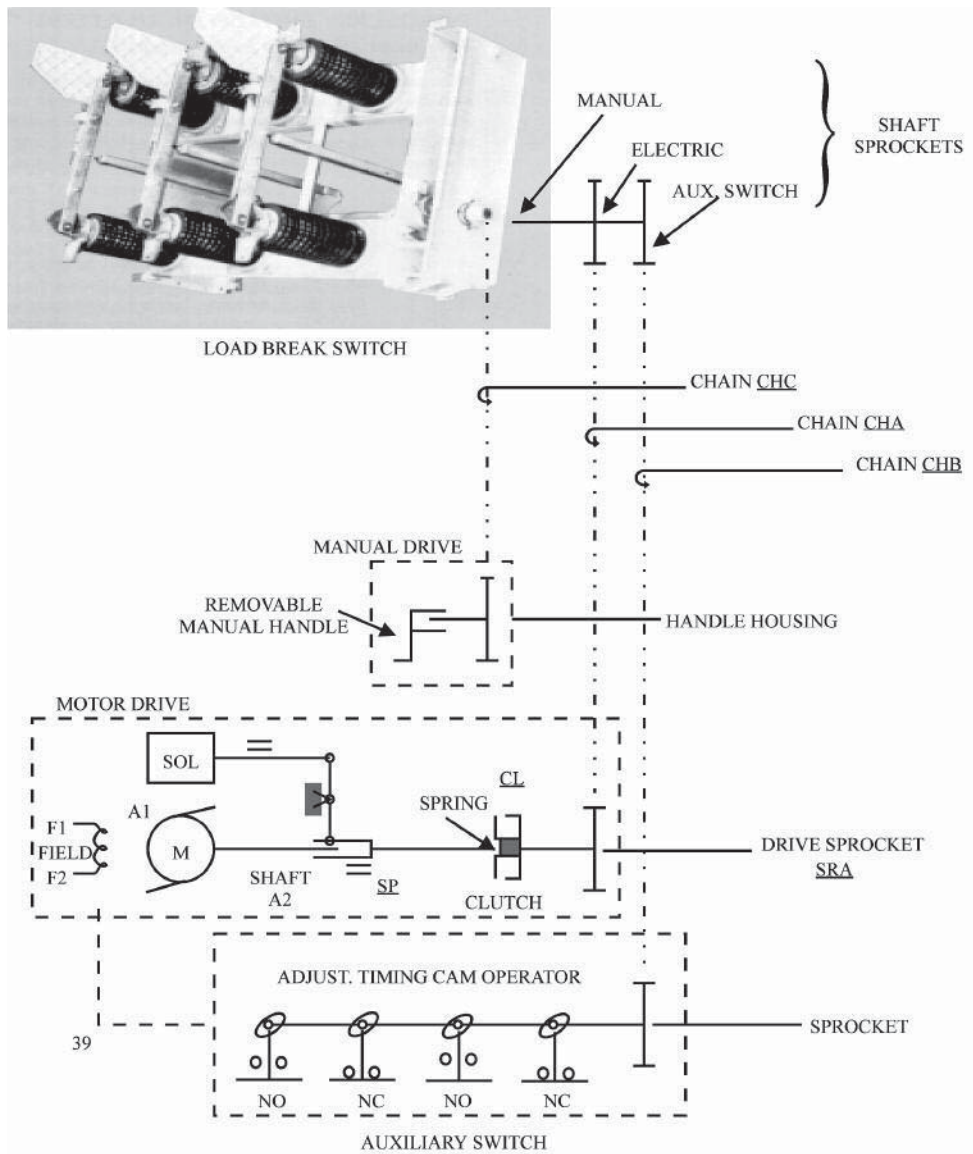

BreakMaster Load Interrupter Switch

Figure 19

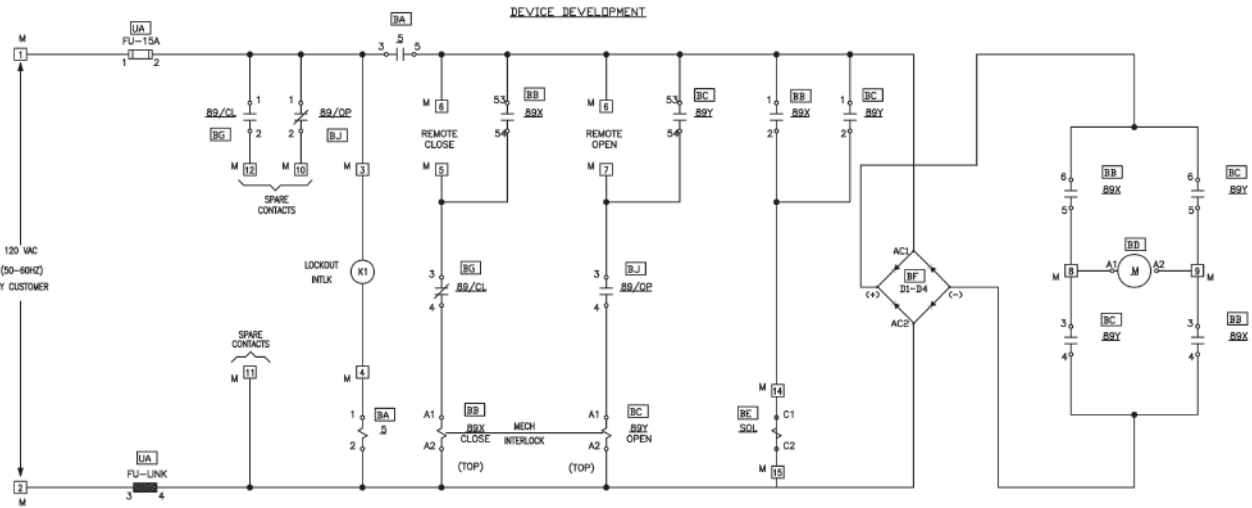

The device numbers used in this diagram are from the American National Institute and descriptions are as follows:

- 5 Stopping Device
- 89 Line Switch
- 89X Closing Relay
- 89Y Opening Relay
- 89/CL Auxiliary Switch on 89 (Closed when 89 is Open)
- 89/OP Auxiliary Switch on 89 (Open when 89 is Open)
- SOL Clutch Solenoid
- A Motor Armature
- FS Fuse
- D1-D4 Diode Bridge (Omitted when control power is DC)

Movement of the solenoid (SOL) compresses spring (SP) and engages clutch (CL). Motor rotates sprocket (SRA) which through its chain drive (CHA) rotates the Load Interrupter Switch drive shaft to close the load break switch.

When the Load Interrupter Switch drive shaft rotates over center, auxiliary switch (89OP/CL) reverses its position, de-energizing the closing relay (89X) to:

1. Stop the motor (A)
2. De-energize solenoid (SOL)
3. Set-up Load Interrupter Switch opening circuits

De-energizing solenoid (SOL) releases compressed springs' (SP) energy to disengage the clutch (CL). Disengagement of the clutch is to prevent the motor armature inertia from overdriving the Load Interrupter Switch drive shaft and causing mechanical damage.

To open the Load Interrupter Switch, apply a signal to the 89Y coil. The Load Interrupter Switch will open in the same manner as described above and set-up the control circuit for a closing signal.

To reverse from either a closing or opening operation, the polarity of the motor armature is reversed.

Decoupling test feature, if required to test motor drive system without moving main switchblades, can be accomplished by inserting a control switch in series with the solenoid (SOL) or simply removing decoupling jumper. (See Figure 19.)

⚠ CAUTION

Do not leave equipment in decoupled mode. If left in that mode, a signal to operate will continuously drive motor without operating Load Interrupter Switch switch blades.

BreakMaster Load Interrupter Switch

Sequence of Operation

(For Exact Wiring and Operation Refer to Drawings Furnished with Equipment) **(Typical)**
Apply the proper control voltage to terminals M1 and M2.

CAUTION

It is essential that the incoming POSITIVE be connected to the POSITIVE terminal of the drive controls and the NEGATIVE be connected to the NEGATIVE of the drive system. Severe damage will be caused if these polarities are reversed.

To Close the Switch:

- a. Return manual handle to the cradle.
b. Turn cradle keylock to capture the key and close its auxiliary contact.
c. Make sure any remote lockout devices in series with the cradle lock switch are closed. Terminals M3-M4 are for this key interlock system.
- Relay 5 is energized to close the 3-5 contacts and energize the control power bus.
- Complete the circuits of M5 and M6 with a momentary closing contact
- 89X circuit is energized through the normally closed 89/CL contact 3-4.
- The 89X contacts 13-14 seal around the remote-close contacts. (Note: 89X-89Y relays are mechanically interlocked to prevent both being closed at the same time).
- Contacts 1-2 of 89X is closed to energize the clutch solenoid (SOL).
- Also contact 5-6 and 3-4 of 89X close, placing the positive DC voltage on motor armature terminal A1. **The motor rotates then to close switch 89.**
- The closing of switch 89 reverses its auxiliary switch 89/CL to open and auxiliary switch 89/OP to close, setting up the opening circuit of 89 upon receipt of an opening signal to terminals M6-M7.
- The opening of 89/CL drops out 89X thereby breaking the seal in contact 89X-13-14. Also opening the 89X contacts deenergizes the motor.

To Open the Switch:

- In the same manner, a remote-open signal placed on terminals M6-M7 will energize 89Y to:
 - Energize clutch solenoid (SOL).
 - Place positive DC on armature terminal A2 to reverse motor direction.
- Once 89 is closed, 89/OP opens to de-energize SOL, stop motor, and 89/CL closes to set up the next closing operation. All as described above.

Adjustments

1. **Wiring Harness Inspection**

Refer to the Wiring Diagram and Schematic shipped with the equipment. Trace out all inter-wiring connections to ensure conformity with the diagram and understanding of all remote interconnect requirements.

2. **Deactivate the Direct Drive Solenoid Coupler Assembly**

- Disconnect the coil wiring on the direct drive solenoid. This is done by disconnecting the three (3) black wires and one (1) grey wire hooked up to Terminal 2 and Terminal I respectively on the coil itself (see Wiring Diagram).
- Isolate the black lead wire from the coil and make sure this wire is isolated and insulated from any power source. Take the remaining two (2) black wires which, if traced back, go to wiring points A2 and AC2, and verify they are jumpered together, allowing power to flow to the DI-D4 bridge. Insulate and isolate the grey wire connected from Point 1 on the solenoid coil.

3. **Checking Motor Rotation**

Hook up your remote close and remote open devices. Energize with the required control voltages. Now check the directional rotation of shaft. The top of the shaft should spin in the same direction as the intended interrupter switch motion. To test, jumper lockout interlocks provision at the M3-M4 terminal connection. Now activate the remote close device. The top of the shaft should be spinning toward the interrupter switch. Now activate the remote open device. The top of the shaft should be spinning toward the front of the cubicle. If this rotation is not correct reverse the power leads to the motor to reverse polarity and therefore reverse rotation of the shaft.

BreakMaster Load Interrupter Switch

4. **Cam Adjustment Procedure**

- a. Make adjustments with all control power off.
- b. Loosen the cam set screws until flush with the cam surface. The cams should rotate freely.
- c. Using the manual handle, operate the interrupter switch to the closed position, rotate the BG cam in the direction of the switch motion to close and set the cam 1/8" past the BG microswitch "click".
- d. Using the manual handle, operate the interrupter switch to the open position, rotate the BJ cam in the direction of the switch motion to open and set the cam 1/8" past the BJ microswitch "click".

NOTE

When the interrupter switch has a "shunt trip" feature, the BK cam must be adjusted. With the switch in the "shunt trip" position, rotate the BK cam until the high point compresses the microswitch and the contact "clicks."

5. **Verify Cam Adjustment**

- a. Verify the direct drive solenoid coil is disconnected.
- b. Energize control power. Initiate the electrical operator.
When the motor starts to run:
 1. Verify motor rotation.
 2. Using the manual handle, throw the switch manually. The motor should be stopped when the primary switch has operated.
 3. Repeat this procedure in both directions. Fine cam adjustment may be required until the above operation is satisfactory.

REMEMBER

The motor operator is designed to charge the spring assembly and travel the operator assembly only to the point where the spring loaded mechanism opens or closes the interrupter switch.

The motor drive does not physically open or close the switch contacts.

After you have followed Points 1 through 5, you are ready to test the electric motor operator utilizing the Direct Drive Motor Assembly.

- Simply remove the lock out interlock jumper at Terminals M3 and M4.
- Reconnect the coil wiring at the solenoid.
- Then remove and store the manual handle.
- Now you will be ready to activate the motor drive through remote devices.

If you find the motor operator cutting off prior to the spring mechanism discharging in the intended direction, adjust the particular cam and microswitch position so as to let the motor operator drive forward slightly longer.

If you find the operator overdriving, adjust the cam to cut the motor drive off earlier.

If Steps 4 and 5 are properly followed, there should be no need for adjustment under an electric operation.

Again, the importance is stressed of properly setting the cams prior to testing in the coupled position with the motor drive assembly. Incorrect setting will cause damage. Please call GE if you have any questions.

BreakMaster Load Interrupter Switch

Inspection and Maintenance:

Control Circuit Parts			
Inspection Item	Criteria	Inspection Method	Corrective Action (if necessary)
Closing and opening devices including disconnects	Smooth and correct operation by control power	Test closing and opening of the switch twice	Replace any defective device
Wiring	Securely tied in proper place	Visual Check	Repair or tie if necessary
Terminals	Tight	Visual Check	Tighten or replace if necessary

Operating Mechanism			
Inspection Item	Criteria	Inspection Method	Corrective Action (if necessary)
Motor	5000 operations	Check condition	Replace brushes
Tightness of hardware	No loose or missing parts	Visual and tightening with appropriate tools	Tighten or reinstate if necessary
Dust or foreign matter	No dust or foreign matter	Visual check	Clean as necessary
Lubrication	Smooth operation and no excessive wear	Sight and feel	Lubricate very sparingly with light machine oil
Deformation or excessive wear	No excessive deformation or wear	Visual and operational	Remove cause and replace parts
Manual operation	Smooth and crisp operation	Manual closing and opening	Correct if necessary

Section 6 – Maintenance

6.0 General Requirements



6.0.1 Periodic Checking

Load break switches should be examined and checked once a year or sooner when conditions require it (such as numerous operations, polluted atmosphere or overloading of the switch). All switches should annually be opened and closed 2-5 times in succession, not exceeding their rated duty.

6.0.2 Cleaning

All switches, including insulators and operating arms, should be thoroughly cleaned periodically by wiping with a clean cloth to prevent accumulations of dust. After cleaning, a light coat of lubrication (non-corrosive, high-temperature grease equivalent to SCH-32 Mobiltemp) should be applied to the contact surfaces. Do not use “cup” or other grease which may harden upon exposure to air.

6.0.3 Contact Inspection

Check to determine that blades make good contact.

A contact resistance measurement between jaw spade terminal and hinge spade terminals should be taken and should be between 35-100 micro-ohms. Insure that the blades can be “opened” from jaw casting with a pulling force of approximately 30-36 pounds measured at a point between the main blades just below the jaw contact as previously described. If force is above 30-36 pounds, see alignment procedure, 4.11.1.

BreakMaster Load Interrupter Switch

These contacts do not tarnish like copper, but they should be “wiped” clean occasionally, especially if the switch has not been operated for some time. This can be done by opening and closing the switch several times in succession.

WARNING

Do not attempt to grind blades with powdered emery or other abrasives.
Such practice inevitably results in poor contact and overheating.

6.0.4 Insulators

It is necessary that the insulators surfaces be kept clean. This is absolutely essential, particularly when the switches are located where cement dust, metallic dust, salt spray, acid fumes and other unfavorable environmental conditions exist. Alcohol cleaner or a light detergent is recommended for cleaning the insulator parts. Make absolutely sure that proper ventilation and other precautions are taken when using any chemical cleaner. Discard and replace any insulators showing signs of tracking.

6.0.5 Insulation Check

When making an annual check, all insulation should be carefully examined for tracking. Special attention must be given to areas where the conductor passes through an insulator or lays near a barrier. Examine the surface for cracks or streaked discoloration. When tracking is found, the insulation involved must be replaced. In such a case, contact your local GE sales office for replacement parts.

6.0.6 Bus and Conductor (Switch Blade) Check

Inspect the buses and connections carefully every year for evidence of overheating or damage. It is desirable to measure the resistance to ground and between phases of the insulation of buses and connections with a meter (or use a megger of proper voltage. A record should be kept of this reading. Weakening of the insulation from one maintenance period to the next can be recognized from the recorded readings. At recording time, the record should include the temperature, the humidity, and the date.

6.0.7 Chain Drive

The chain drive assembly connects the stored energy mechanism to the operating handle on the front of the housing. It consists of a length of roller type chain fastened in a loop by two adjustable turnbuckles with locking nuts. Make sure turnbuckles and locking nuts are tight. No adjustments are necessary.

6.0.8 Operating Shaft

The operating shaft connects the stored energy mechanism to the switch operating arms. The shaft is integral with the switch assembly and is bearing mounted. Light lubricant applied to bearing surfaces will insure trouble free operation. No adjustments are necessary.

6.0.9 Pushrods

Each main blade of the switch is connected to the throw arms or the main operating shaft by an insulated pushrod. These pushrods should be examined during each normal maintenance procedure for signs of damage to either end. If a damaged pushrod is encountered, replacement parts are needed.

6.0.10 Stored Energy Mechanism

The stored energy mechanism consists of a housing with a one piece crank sprocket assembly supported by bearings and a spring assembly.

The sprocket assembly is chain driven by means of a handle on the front of the housing. As the handle is moved upward, the spring assembly is charged. As the crank sprocket assembly passes over dead center, the spring takes over and drives the switch to the closed position. The unit is factory adjusted and should need no adjustment in the field.

Check to make sure the latches rotate freely up and down by using finger pressure on the rollers. Check for loose bearing bolts.

BreakMaster Load Interrupter Switch

6.0.11 Lubrication

The load break interrupted switch requires infrequent lubrication. Bearing points and sliding surfaces should be lubricated at the regular inspection periods (annually) with a thin film of low temperature lubricant. Before lubrication, remove any hardened grease and dirt from latch and bearing surfaces with kerosene, varsol, or naphtha.

The contact surface of the movable blades and the stationary contact surface should be cleaned and greased with SCH-32 Mobiltemp.

6.0.12 High Potential Tests

High potential tests to check the integrity of the insulation are not necessary if the insulation maintenance instructions in this book are carefully followed. Should the purchaser desire to make high potential tests, the test voltage should not exceed 14 kV A.C. for 4.16KV and 27 kV A.C. for 13.8 kV. These voltages are 75% of factory test voltages and are in accordance with ANSI standards. Make sure any test performed conforms to all applicable OSHA, ANSI and NEC standards.

Section 7 – Selector Switch Configuration

When supplied, a two position non load break selector switch is connected in series with the BreakMaster load break switch. The two switches are key interlocked. To operate the selector switch, the BreakMaster switch must be in the off position.

Since the selector switch is a non load break switch, speed of operation is not essential for safe operation. However, to insure good contact when changing feeders, move the handle rapidly and forcefully when changing feeder positions.

Section 8 – Duplex Switchgear Configuration

When supplied, the duplex configuration consists of two BreakMaster Load Interrupter Switches connected by a common load side bus. If fusing is included, it normally consists of only one set of fuses located in one of the switch compartments between the load side bus and outgoing terminals. This arrangement allows the selection of either of two incoming lines.

As standard, this arrangement is supplied with key interlocking for safe operation. Key interlocking normally consists of a lock on each switch and a lock on each door. Each of the locks is keyed alike and only one key should be available to operating personnel. Since the key is retained in its lock when a switch is closed or when a door is opened, two things are assured:

- a. Only one switch may be closed at a time to prevent paralleling of incoming lines.
- b. Both switches must be locked in the open position to unlock either main door, preventing access to energized load side bus or fuses.

WARNING

Only one key should be available to operating personnel for this interlock scheme.
When shipped from the factory, each lock will have a separate key.
All extra keys must be destroyed or otherwise made inaccessible to operating personnel. Failure to do so could result in severe injury or death.

Section 9 – Auto Transfer Switchgear (LIS-ATS) Configuration

When supplied, the LIS-ATS configuration consists of two motor-operated BreakMaster Load Interrupter Switches and, in the middle, a control panel section connected by a common load side bus. This arrangement allows the automatic selection of either of two incoming lines (Normal or Emergency).

Lower section of the control panel section consists of a bus arrangement for cable exit as well as for bus connection of two motor-operated LIS switches. Upper section of control panel consists of an MX250 module, RT box and relays, which help the product to detect the current supply and to give the signal to toggle the switch for restoring the power supply. Upper door of control panel consists of indication lamps, Auto/Manual selector switch and Reset push button to show the status of and to control ATS manually.

As standard, this arrangement is supplied with key interlocking for safe operation. Key interlocking normally consists of a lock on each switch and a lock on each door. Each of the locks is keyed alike and only one key should be available to operating personnel. Since the key is retained in its lock when a switch is closed or a door is opened, this requires that both switches must be locked in the open position to unlock either main door, preventing access to energized load side bus or fuses. See GE Zenith Operation and Maintenance Manual #71R-2000A for more information.

WARNING

Only one key should be available to operating personnel for this interlock scheme. When shipped from the factory, each lock will have a separate key. All extra keys must be destroyed or otherwise made inaccessible to operating personnel. Failure to do so could result in severe injury or death.

BreakMaster Load Interrupter Switch

Sequence of Operation for Controller MX250-LIS

See GE Zenith document 71R-2000A for more details

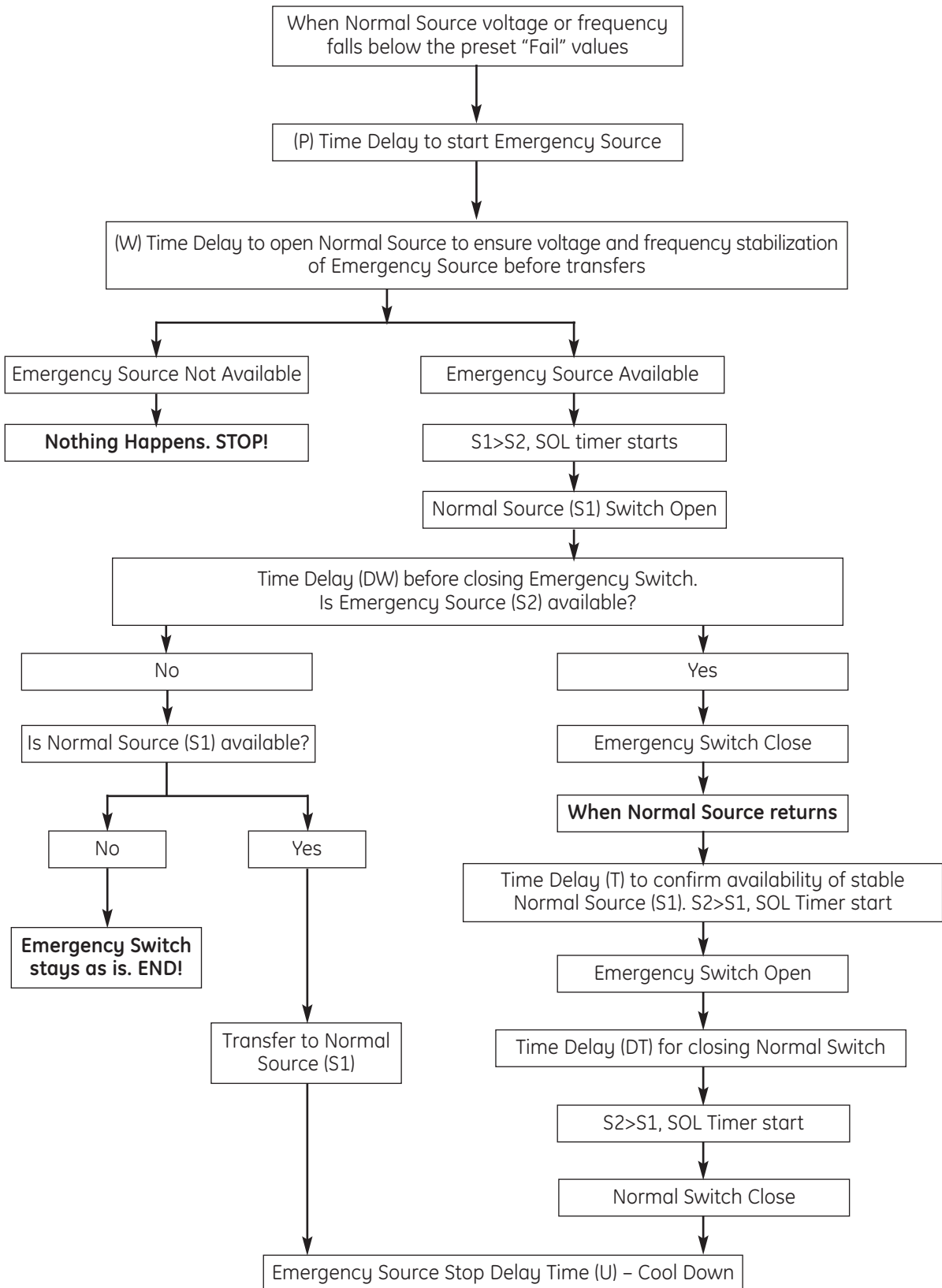

Section 10 – Troubleshooting

Trouble	Cause	Remedy
Overheating	Overload	If the switch is overheated because of excess current, one of two remedies can be adopted: Replace with a switch of rating adequate for the present or future loads, or: Rearrange circuits to remove excess load.
	Poor Contact (Contact out of adjustment)	Adjust Contacts (See Section 4.11.1)
	Connections to Switch not of adequate current carrying capacity.	Increase the capacity of the connections by adding conductors or by replacing with heavier conductors.
	Contacts Burned or Pitted	Contacts should be dressed and fitted properly. (See Section 4.11.1)
	Bolts and Nuts of Connections not tight	Tighten all bolts and nuts. (Do not exceed torque as per Section 4.2 by more or less than 10 percent. Over-tightening bolts may cause bolts to exceed their elastic limit, leading to more loosening of the connections.)
	Located in too hot an ambient (40°C Max.). (Such as too close to a boiler, a furnace or the like)	Relocate in a cooler place or arrange some means of cooling.

⚠ WARNING

Do not exceed 40°C as maximum ambient temperature.